

## 10G Quad segment, multi-function bypass and active Tap

The Niagara 2818 network bypass device is part of the Niagara BypassP<sup>2</sup> product line. The 2818 provides four 1/10Gb bypass segments, active Tap versatility and multi functionality.

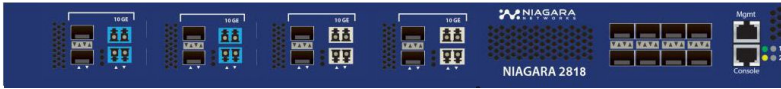

Figure 1: 2818 front panel with four bypass segments (2\*multimode, 2\*single mode), and an additional eight fixed configuration active monitoring ports (on RHS)

## Multifunctional BypassP<sup>2</sup> Segment

A full bypass segment comprises two network and two appliance ports. The network ports offer direct single mode (SM) or multimode (MM) connectivity. The appliance ports utilize SFP+, giving the flexibility to connect appliances (tools) using 1Gb or 10Gb, whether SM, MM or copper. The unique use of dual rate, integrated 1/10Gb transceivers on the network ports connects the network traffic to a common, non-blocking switching fabric layer. This feature enables the 2818 to support of both 1Gb and 10Gb appliance links.

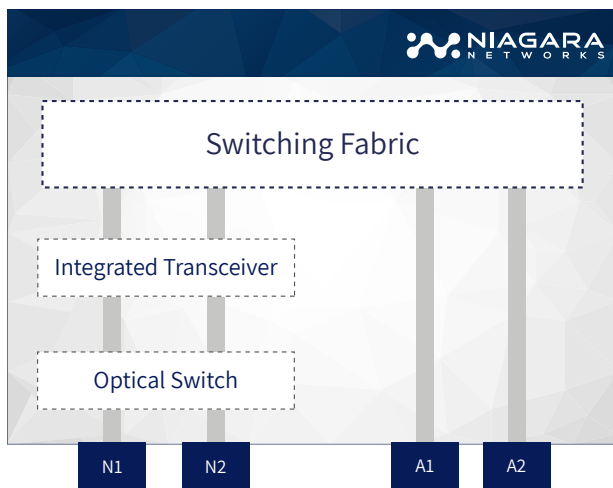

Figure 2: multi-purpose 4-port segment

## Product Highlights

### High Density:

- Up to 4 full 1/10Gb bypass segments
- Double protection bypass technology

### Multi-functional Segments

- Each segment comprises 2\*Network ports and 2\*Appliance ports
- Network ports support SX/SR and LX/LR
- Bypass for inline deployments
- Active Tap split mode
- Active Tap aggregate mode

### Management:

- Robust command line interface (CLI)
- User-friendly, web-based user interface
- REST API for third-party integration and support
- Managed by Niagara Visibility Controller (NVC)

### Integrated Monitoring/Tap Ports:

- Up to 8 additional fixed-configuration active or passive monitoring/Tap ports

### Form Factor:

- 1U Rackmount
- Dual field-replaceable power supply



### Fabric Flow:

Mapping traffic flow relationships between source and destination ports

- Multi-functional bypass segment configuration
- High availability between primary and secondary bypass segments
- User-configurable packet heartbeat (ms resolution)

# Network Bypass Technology

Our signature BypassP<sup>2</sup> offers double-protection bypass technology. A failsafe optical relay on network ports, and a user-configurable heartbeat-generated packets on appliance ports.

In Bypass/Inline deployments, traffic from one side of the network is forwarded to the inline appliance, and through the inline appliance to the other side of the network. This is the common network deployment for inline security devices such as firewalls and intrusion detection systems.

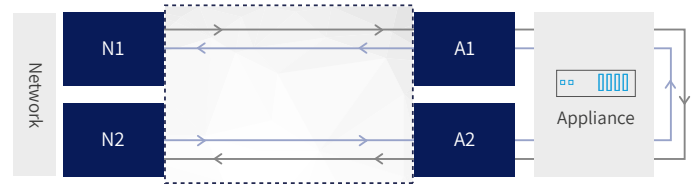

Figure 3: Inline deployment

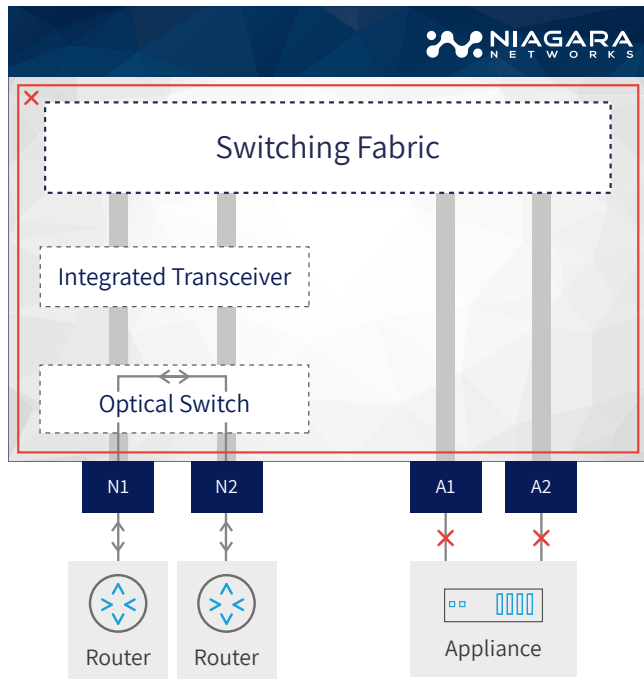

Figure 4: Power Failure Mode

**Failsafe protection** - protecting network traffic flow in the event of BypassP<sup>2</sup> failure. When power fails, as depicted in figure 4, the optical-relays ensure that the network flow continues uninterrupted. The optical relays can be configured fail open or fail close to meet specific deployment needs. An optical switch mechanism is the most reliable method for connecting inline devices to your network, while ensuring uninterrupted network services under all conditions.

**Heartbeat protection** - protecting network traffic flow in case of appliance failures. The BypassP<sup>2</sup> transmits a user-configurable heartbeat on the appliance ports as depicted in figure 5. In the event of an appliance malfunction (such as a software crash, system failure or loss of power depicted in figure 6), the failure is detected, and the BypassP<sup>2</sup> bypasses the traffic intended for the inline appliance to the network ports, allowing it to continue to flow through the network link. This feature also enables the network appliances to be removed and replaced without network downtime. Once the system is back up, or the power is restored to the appliance, it is detected by the BypassP<sup>2</sup> heartbeat mechanism, and network traffic is seamlessly diverted back to the inline device, allowing it to resume its critical functions.

Niagara's heartbeat mechanism is an integrated configurable sub-second-rate mechanism that is available independently for each segment. The number of missed heartbeat packets before entering bypass mode is configurable, so too is the number of received heartbeats to determine that the appliance is back on-line. BypassP2 heartbeat does not require additional drivers to be installed on connected appliances.

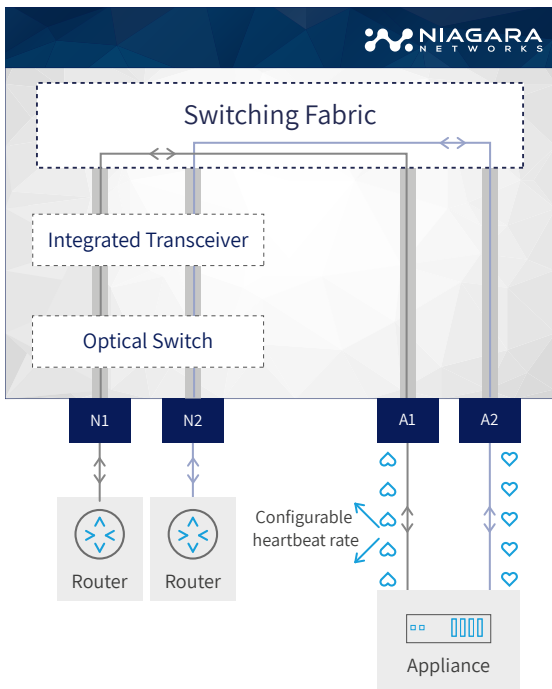

Figure 5: Normal inline Operation Mode

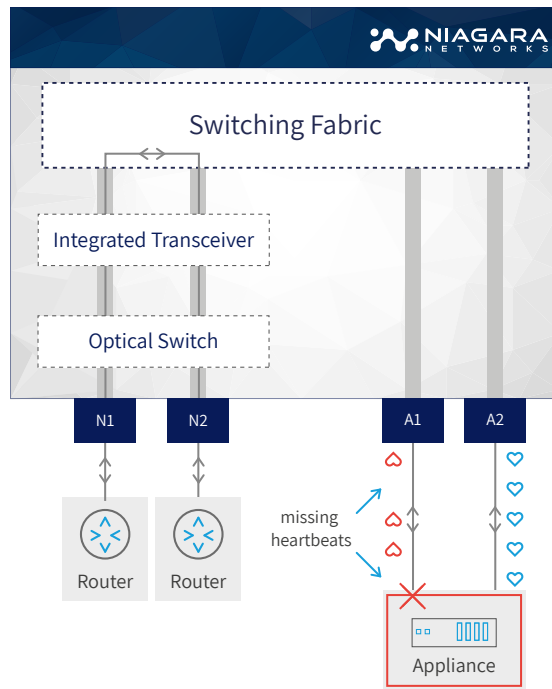

Figure 6: Appliance Failure Mode

## Active Tap (aggregation)

The bypass segment is configured as an active Tap, supporting one network link. Traffic on the network side is always maintained. Each appliance port receives a copy of the Rx from both sides of the network. This mode economizes on monitoring tool ports, in case the total traffic throughput from both network sides is below that of the single appliance port.

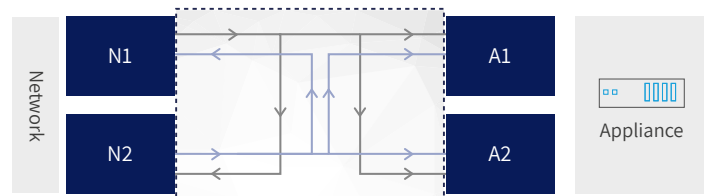

Figure 7: Active Tap (aggregation)

## Active Tap (split)

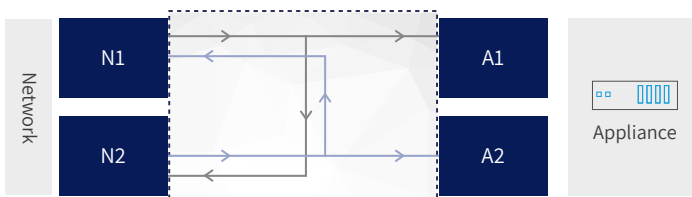

Figure 8: Active Tap (split)

The bypass segment is configured as an active Tap, supporting one network link. Traffic on the network side is always maintained. Each appliance port receives a copy of the Rx from one of the network ports.

# Manual Active Bypass

In this mode, the segment becomes transparent to the network traffic. Network traffic flows unimpeded between N1 and N2. This mode is useful for carrying out maintenance on appliances and inline deployment without bringing the network side down

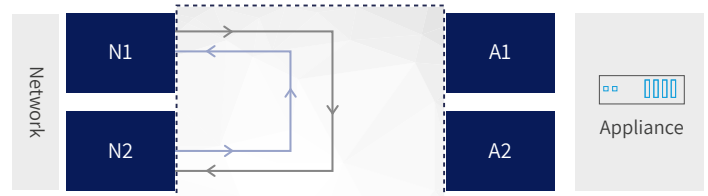
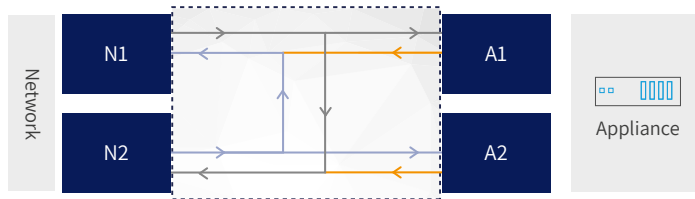

Figure 9: Manual Active Bypass Mode

# Injection Mode



The bypass segment is configured to enable the appliance to inject traffic back to the network. Traffic on the network side is always maintained. Each appliance port receives a copy of the Rx from one of the network ports, but is also enabled to inject traffic to the network ports

Figure 10: Injection Mode

# Configuration Flexibility

In addition to the four bypass segments, each with two network ports and two appliance/Tap ports, the 2818 can be optionally configured with additional fixed-configuration monitoring/Tap port options:

- No monitoring ports
- 8 ports for passive monitoring/Tap
- 8 ports for active monitoring/Tap

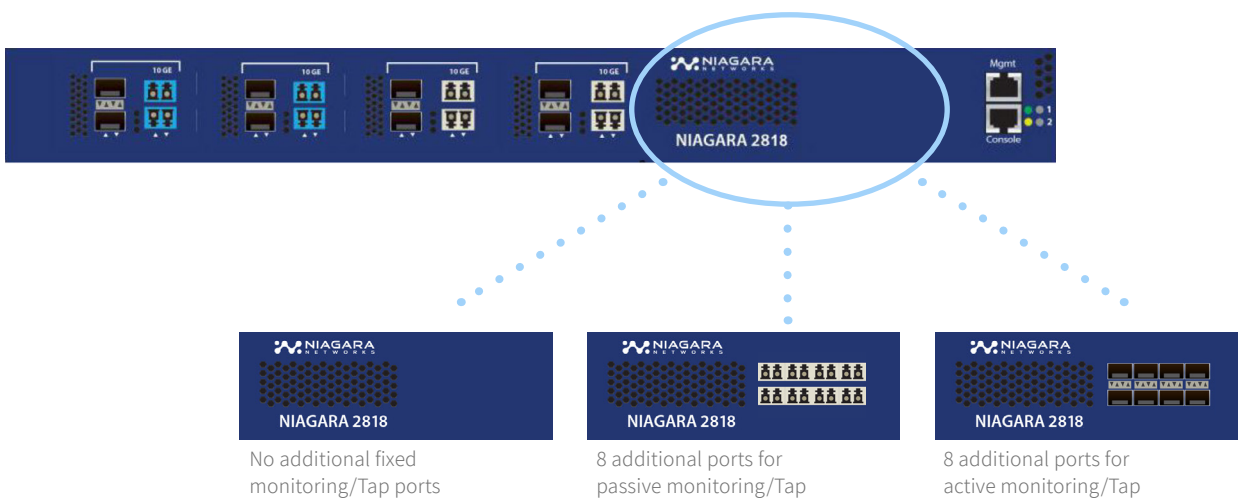

Figure 11: 2818 front panel depicting the optional configuration of the additional integrated fixed-configuration monitoring/Tap options

## Integrated Active Monitoring/Tap

The eight monitoring/Tap ports provide an additional, fixed Tap configuration on top of those available as part of the bypass segment. In the fixed configuration N1(Rx) is connected to T1 monitoring port, N2(Rx) is connected to T2 monitoring port, etc. as depicted in Figure 12. This provides the flexibility to have an additional integrated Tap for more tools. If the power fails, the network traffic flow is maintained, however the integrated active Tap point losses its visibility.

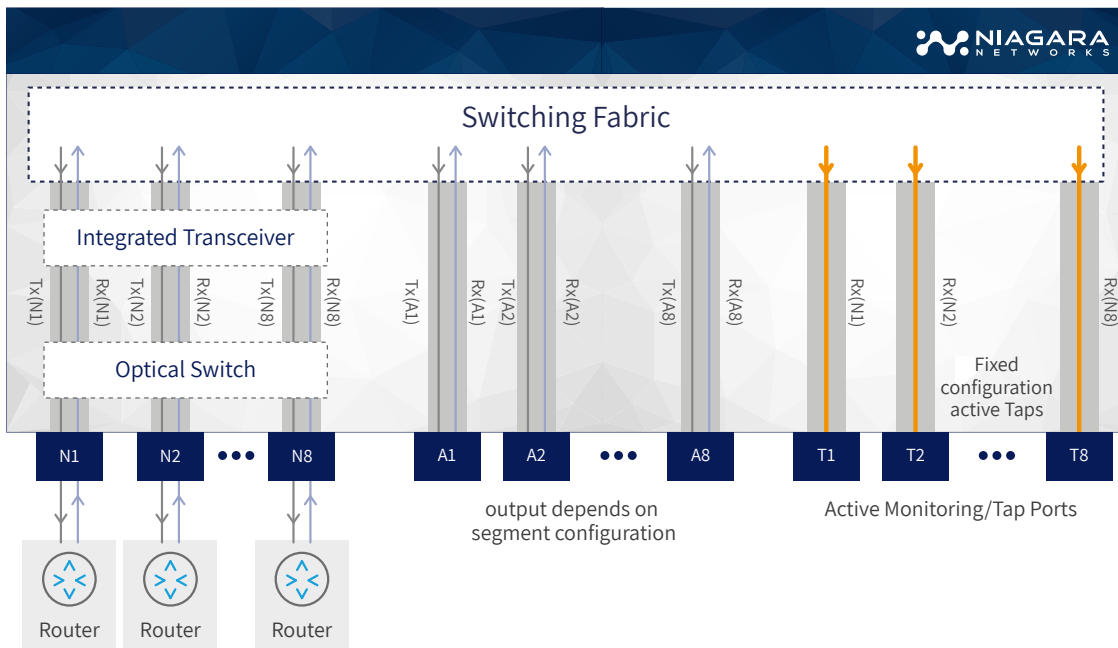

Figure 12: Integrated active monitoring/Tap functionality

## Integrated Active Monitoring/Tap

The eight monitoring/Tap ports provide an additional fixed Tap configuration on top of those available as part of the bypass segment. In the fixed configuration, N1(Rx) is connected to T1 passive monitoring port, N2(Rx) is connected to T2 passive monitoring port, etc. This provides the flexibility to have an additional integrated Tap for more tools. In case of power failure, the monitoring/Tap ports flows are maintained, as they are connected with passive splitters directly to the corresponding network ports, as depicted in Figure 13.

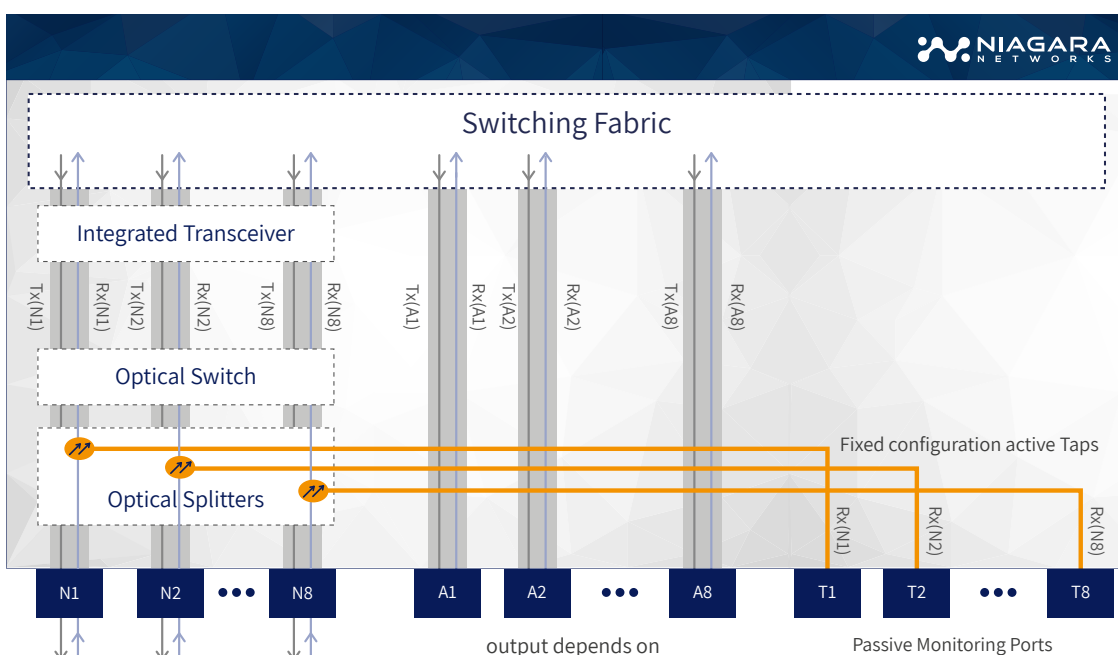

Figure 13: Integrated passive monitoring/Tap functionality

Specifications			
Height	1.74 inches (44.20 mm)	Max Raw Power	173.75 Watts
Length	19.98 inches (507.49 mm)	Max Power Consumption	139 Watts
Width	17.25 inches (438.15 mm)	Airflow	Front to back
Weight	19 lbs (8.62 kg)	AC	100-240V, 50/60 Hz., 5.29-2.2 A
Operating Temp	32 to 113 °F (0 to 45 °C)	DC	36-72V, 5A
Operating Humidity	5 to 95%		

Emissions	Immunity
FCC Part 15B, ICES 003, EN55032	EN55024

Safety	Certifications
UL/CSA 60950-1, EN 60950-1, IEC 60950-1 CB Scheme with all country differences	North America (NRTL) European Union (EU) VCCI (Japan) 2014/35/EU Low Voltage Directive 2014/30/EU EMC Directive 2011/65/EU RoHS Directive 2012/19/EU WEEE Directive

Part Number	Description	Ordering Details
2818-MN-xx	2818 BypassP <sup>2</sup> main chassis. Supports four 4-port segments (segments ordered separately). Two redundant power supply units and four fan units.	xx - specify preferred power supply option AC - Dual AC redundant power supply DC - Dual DC redundant power supply
2818-MN-8xx-yy	2818 BypassP <sup>2</sup> main chassis with integrated monitoring/Tap ports. Supports four 4-port segments (segments ordered separately). Two redundant power supply units and four fan units.	xx - specify additional fixed configuration monitoring/Tap port options ATP - 2818 main platform plus built-in 8 active Tap ports. Transceivers for active monitoring/Tap ports sold separately PTP - 2818 main platform plus built-in 8 passive Tap ports. The Split Ratio in fixed configuration passive Tap ports is based on the split ratio of the selected bypass segment yy - specify preferred power supply option AC - Dual AC redundant power supply DC - Dual DC redundant power supply
2800-SG-xx	4-port segment for 2818. Order when selected 2818 rackmount has no fixed configuration Tap ports or with the 8 fixed configuration active Tap ports	xx - specify network side fiber type: SR - multimode 50/125 SR5 - multimode 62.5/125 LR - singlemode Transceivers for appliance ports ordered separately
2800-SG-xx-yy	4-port segment for 2818. Order when selected 2818 has 8 fixed configuration passive Tap ports	xx - specify network side fiber type: SR - multimode 50/125 SR5 - multimode 62.5/125 LR - singlemode Transceivers for appliance ports ordered separately yy - specify required network/monitor split ratios: 90 = 90/10; 80 = 80/20; 70 = 70/30; 60 = 60/40; 50 = 50/50

## About Niagara Networks

Niagara Networks provides high performance network visibility solutions for seamless administration of security solutions, performance management and network monitoring. Niagara Networks products provide advantages in terms of network operation expenses, downtime, and total cost of ownership.

A former division of Interface Masters, Niagara Networks provides all the building blocks for an advanced Visibility Adaptation Layer at all data rates up to 100Gb, including Taps, bypass elements, packet brokers and a unified management layer. Thanks to its integrated in-house capabilities and tailor-made development cycle, Niagara Networks are agile in responding to market trends and in meeting the customized needs of service providers, enterprise, data centers, and government agencies.

2818 2018 Version 1